

# Panasonic®

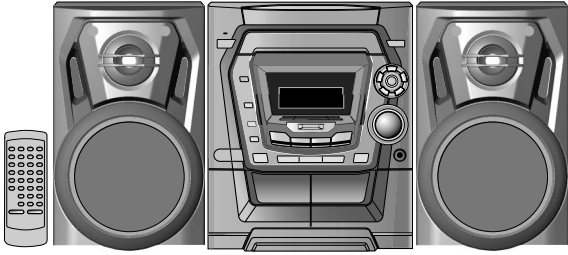

## CD Stereo System

### Operating Instructions

Model No. **SC-AK100**



As an ENERGY STAR® Partner, Panasonic has determined that this product meets the ENERGY STAR® guidelines for energy efficiency.

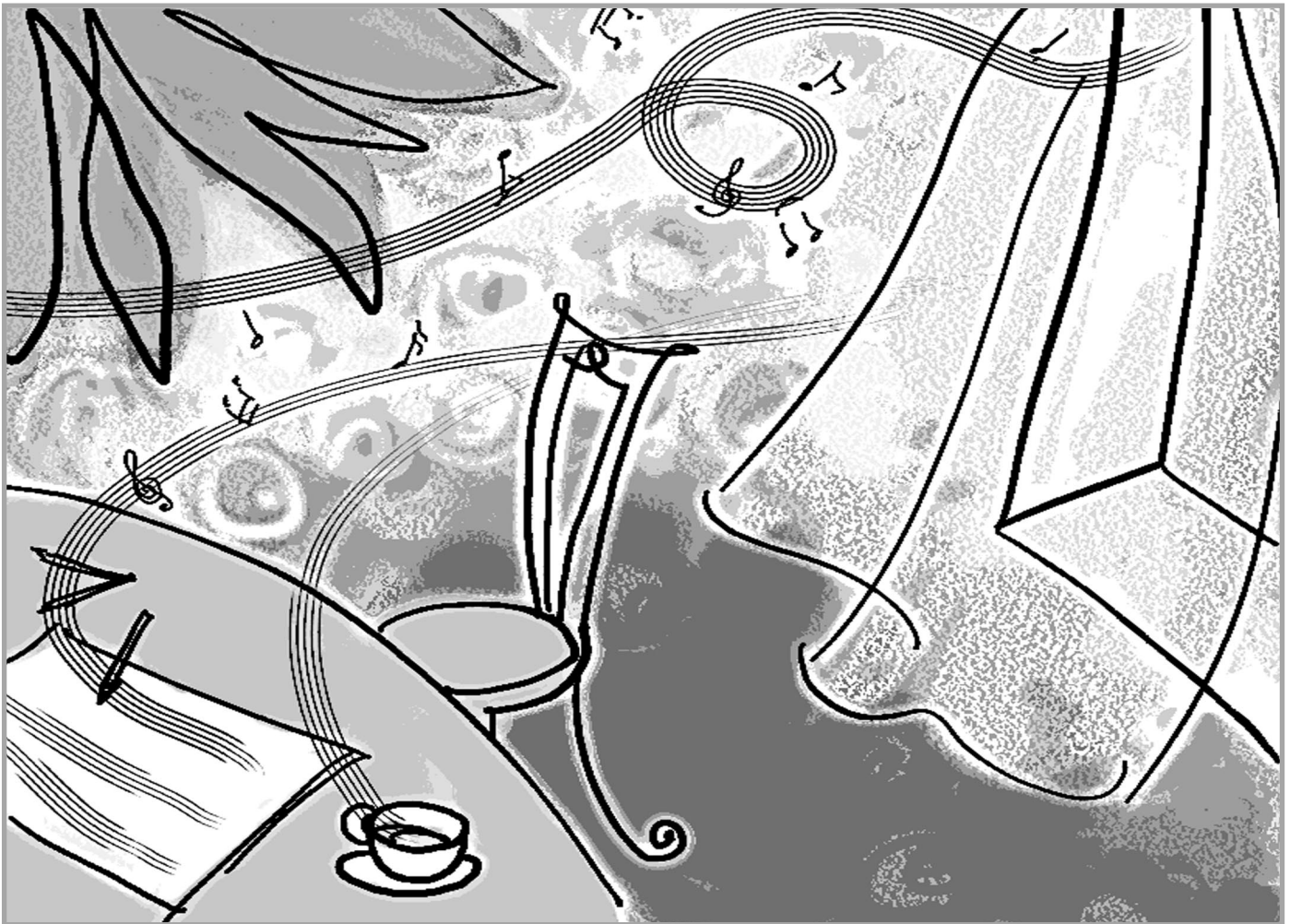

**COMPACT**  
**disc**  
DIGITAL AUDIO

Before connecting, operating or adjusting this product, please read these instructions completely.  
Please keep this manual for future reference.

**For U.S.A. only**

The servicer list and warranty can be found on pages 15 and backcover.

P PC

RQT6351-1P

# Table of contents

## Dear customer

Thank you for purchasing this product. For optimum performance and safety, please read these instructions carefully.

These operating instructions are applicable to the following system.

<b>System</b>	SC-AK100
<b>Main unit</b>	SA-AK100
<b>Speakers</b>	SB-AK100

### CAUTION!

THIS PRODUCT UTILIZES A LASER. USE OF CONTROLS OR ADJUSTMENTS OR PERFORMANCE OF PROCEDURES OTHER THAN THOSE SPECIFIED HEREIN MAY RESULT IN HAZARDOUS RADIATION EXPOSURE. DO NOT OPEN COVERS AND DO NOT REPAIR YOURSELF. REFER SERVICING TO QUALIFIED PERSONNEL.

### WARNING:

TO REDUCE THE RISK OF FIRE, ELECTRIC SHOCK OR PRODUCT DAMAGE, DO NOT EXPOSE THIS APPARATUS TO RAIN, MOISTURE, DRIPPING OR SPLASHING AND THAT NO OBJECTS FILLED WITH LIQUIDS, SUCH AS VASES, SHALL BE PLACED ON THE APPARATUS.

### CAUTION:

TO PREVENT ELECTRIC SHOCK MATCH WIDE BLADE OF PLUG TO WIDE SLOT, FULLY INSERT.

### CAUTION!

DO NOT INSTALL, OR PLACE THIS UNIT, IN A BOOKCASE, BUILT-IN CABINET OR IN ANOTHER CONFINED SPACE. ENSURE THE UNIT IS WELL VENTILATED. TO PREVENT RISK OF ELECTRIC SHOCK OR FIRE HAZARD DUE TO OVERHEATING, ENSURE THAT CURTAINS AND ANY OTHER MATERIALS DO NOT OBSTRUCT THE VENTILATION VENTS.



CAUTION: TO REDUCE THE RISK OF ELECTRIC SHOCK, DO NOT REMOVE SCREWS. NO USER-SERVICEABLE PARTS INSIDE. REFER SERVICING TO QUALIFIED SERVICE PERSONNEL.



The lightning flash with arrowhead symbol, within an equilateral triangle, is intended to alert the user to the presence of uninsulated "dangerous voltage" within the product's enclosure that may be of sufficient magnitude to constitute a risk of electric shock to persons.



The exclamation point within an equilateral triangle is intended to alert the user to the presence of important operating and maintenance (servicing) instructions in the literature accompanying the appliance.

<b>IMPORTANT SAFETY INSTRUCTIONS</b> .....	<b>3</b>
<b>Listening caution</b> .....	<b>4</b>
<b>Supplied accessories</b> .....	<b>4</b>
<b>The remote control</b> .....	<b>4</b>
<b>Set-up</b> .....	<b>5</b>
<b>Front panel controls</b> .....	<b>6</b>
<b>The radio: manual tuning</b> .....	<b>7</b>
<b>The radio: preset tuning</b> .....	<b>7</b>
<b>CDs</b> .....	<b>8</b>
<b>Cassettes</b> .....	<b>10</b>
<b>Using the built-in sound quality</b> .....	<b>10</b>
<b>Enhancing the sound quality</b> .....	<b>10</b>
<b>Recording</b> .....	<b>10</b>
<b>Optional antenna connections</b> .....	<b>11</b>
<b>External unit connections</b> .....	<b>11</b>
<b>Using an external unit</b> .....	<b>11</b>
<b>Using headphones (not included)</b> .....	<b>11</b>
<b>Turning the demo function off</b> .....	<b>12</b>
<b>Convenient functions</b> .....	<b>12</b>
<b>Auto-off function</b> .....	<b>12</b>
<b>Setting the time</b> .....	<b>12</b>
<b>Using the timers</b> .....	<b>13</b>
<b>Troubleshooting guide</b> .....	<b>14</b>
<b>Maintenance</b> .....	<b>14</b>
<b>Product Service</b> .....	<b>15</b>
<b>Servicenter List (ONLY FOR U.S.A.)</b> .....	<b>15</b>
<b>Specifications</b> .....	<b>Back cover</b>
<b>Warranty (ONLY FOR U.S.A.)</b> .....	<b>Back cover</b>

### THE FOLLOWING APPLIES ONLY IN THE U.S.A.:

#### CAUTION:

This equipment has been tested and found to comply with the limits for a Class B digital device, pursuant to Part 15 of the FCC Rules.

These limits are designed to provide reasonable protection against harmful interference in a residential installation. This equipment generates, uses and can radiate radio frequency energy and, if not installed and used in accordance with the instructions, may cause harmful interference to radio communications. However, there is no guarantee that interference will not occur in a particular installation. If this equipment does cause harmful interference to radio or television reception, which can be determined by turning the equipment off and on, the user is encouraged to try to correct the interference by one or more of the following measures:

- Reorient or relocate the receiving antenna.
- Increase the separation between the equipment and receiver.
- Connect the equipment into an outlet on a circuit different from that to which the receiver is connected.
- Consult the dealer or an experienced radio/TV technician for help.

Any unauthorized changes or modifications to this equipment would void the user's authority to operate this device.

This device complies with Part 15 of the FCC Rules. Operation is subject to the following two conditions: (1) This device may not cause harmful interference, and (2) this device must accept any interference received, including interference that may cause undesired operation.

The model number and serial number of this product can be found on either the back or the bottom of the unit. Please note them in the space provided below and keep for future reference.

MODEL NUMBER \_\_\_\_\_

SERIAL NUMBER \_\_\_\_\_

#### User memo:

DATE OF PURCHASE \_\_\_\_\_

DEALER NAME \_\_\_\_\_

DEALER ADDRESS \_\_\_\_\_

TELEPHONE NUMBER \_\_\_\_\_

## IMPORTANT SAFETY INSTRUCTIONS

Read these operating instructions carefully before using the unit. Follow the safety instructions on the unit and the safety precautions listed below. Keep these operating instructions handy for future reference.

### Safety

- 1. Power source**—Connect the unit to a power source of the type described in these instructions or as marked on the unit.
- 2. Polarization**—The unit is equipped with a polarized power plug where one blade is wider than the other. This safety feature ensures that the plug fits into your household AC outlet only one way. If the plug doesn't fit one way, try reversing it. If the plug still doesn't fit, contact an electrician to replace the obsolete outlet. Do not attempt to defeat the safety purpose of the plug.
- 3. Power cord protection**—Route the AC power supply cord so that it will not be walked on or pinched by items placed on or against it. Never take hold of the plug or cord with wet hands. Always grasp the plug body firmly when connecting and disconnecting it.
- 4. Overloading**—When connecting the AC power supply cord, be careful not to overload the household AC outlet, extension cord, or outlet from any other device as this can result in fire or electric shock.
- 5. Nonuse periods**—Turn the unit off when it is not in use. Unplug the unit from the household AC outlet if it is not to be used for a long time. Unplug the unit during lightning storms.
- 6. Attachments and accessories**—Use only the attachments and accessories recommended in these operating instructions.

### Installation

#### Placement

- 1. Ventilation**—Situate the unit so that it receives proper ventilation. Do not install in a confined space such as a bookcase or cabinet. Allow at least 10 cm (4 inches) clearance from the rear of the unit. To prevent the risk of electric shock or fire due to overheating ensure curtains and other materials do not obstruct the unit's ventilation.
- 2. Foreign material**—Ensure objects and liquids do not get into the unit. Avoid exposing the unit to excessive smoke, dust, mechanical vibration, and shock.
- 3. Magnetism**—Situate the unit away from equipment and devices that generate strong magnetic fields.
- 4. Stacking**—Do not place heavy objects on top of this unit.
- 5. Surface**—Place the unit on a flat, level surface.
- 6. Carts and stands**—Use the unit only with carts and stands recommended by the manufacturer. Move carts with care. Sudden stops, excessive force, and uneven surfaces can cause carts to overturn. 
- 7. Wall and ceiling mounting**—Do not mount the unit on walls or ceilings unless specified in the instructions.

#### Environment

- 1. Water and moisture**—Do not use the unit near water, such as near a bathtub or swimming pool. Avoid damp basements.
- 2. Heat**—Situate the unit away from heat sources, such as radiators. Do not situate where temperatures fall below 5°C (41°F) or rise above 35°C (95°F).

- 3. Power lines**—Take care when setting up an outdoor antenna that it is not near overhead power lines, electric lights, or electrical circuits, and that there is no danger of the antenna falling on power lines, electric lights, or electrical circuits. When installing an outdoor antenna, take extreme care not to touch such power lines or circuits, as contact with them can be fatal.
- 4. Outdoor antenna grounding**—If you connect an outdoor antenna, ground the antenna system to protect against voltage surges and built-up static charges. Section 810 of the National Electrical Code, ANSI/NFPA No. 70-1990, provides information about grounding of the mast and supporting structure, grounding of the lead-in wire to an antenna discharge unit, size of grounding conductors, location of antenna-discharge unit, connection to grounding electrodes, and requirements for the grounding electrode. Refer to this diagram.

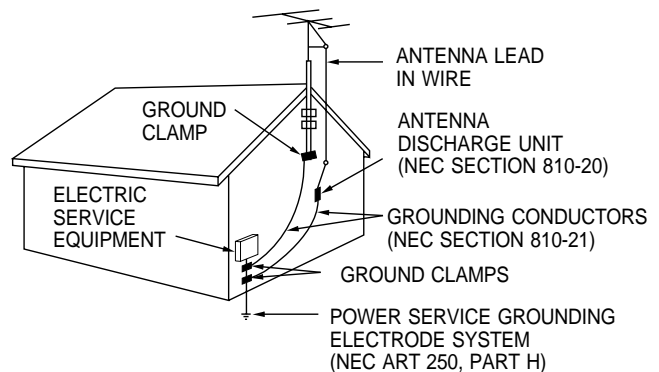

NEC—NATIONAL ELECTRICAL CODE

### Maintenance

(See page 14 for details.)

Unplug the unit from the household AC outlet before cleaning. Clean with a damp cloth. Do not use abrasive pads, scouring powders, or solvents.

### Service

- 1. Damage requiring service**—The unit should be serviced by qualified service personnel if:
  - (a) The AC power supply cord or the plug has been damaged; or
  - (b) Objects or liquids have gotten into the unit; or
  - (c) The unit has been exposed to rain; or
  - (d) The unit does not operate normally or exhibits a marked change in performance; or
  - (e) The unit has been dropped or the cabinet damaged.
- 2. Servicing**—Do not attempt to service the unit beyond that described in these operating instructions. Refer all other servicing to authorized servicing personnel.
- 3. Replacement parts**—When parts need replacing ensure the servicer uses parts specified by the manufacturer or parts that have the same characteristics as the original parts. Unauthorized substitutes may result in fire, electric shock, or other hazards.
- 4. Safety check**—After repairs or service, ask the servicer to perform safety checks to confirm that the unit is in proper working condition.

## Listening caution



Selecting fine audio equipment such as the unit you've just purchased is only the start of your musical enjoyment. Now it's time to consider how you can maximize the fun and excitement your equipment offers. This manufacturer and the Electronic Industries Association's Consumer Electronics Group want you to get the most out of your equipment by playing it at a safe level. One that lets the sound come through loud and clear without annoying blaring or distortion—and, most importantly, without affecting your sensitive hearing.

We recommend you to avoid prolonged exposure to excessive noise.

Sound can be deceiving. Over time your hearing "comfort level" adapts to higher volumes of sound. So what sounds "normal" can actually be loud and harmful to your hearing.

Guard against this by setting your equipment at a safe level BEFORE your hearing adapts.

To establish a safe level:

- Start your volume control at a low setting.
- Slowly increase the sound until you can hear it comfortably and clearly, and without distortion.

Once you have established a comfortable sound level:

- Set the dial and leave it there.

Taking a minute to do this now will help to prevent hearing damage or loss in the future. After all, we want you listening for a lifetime.

## Supplied accessories



Please check and identify the supplied accessories. Use numbers indicated in parentheses when asking for replacement parts.

**(Only for U.S.A.)**

To order accessories contact 1-800-332-5368 or web site (<http://www.panasonic.com>).

- AC power supply cord.... 1 pc.  
(RJA0065-1D)

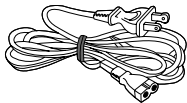

- FM indoor antenna..... 1 pc.  
(RSA0006-J)



- AM loop antenna..... 1 pc.  
(N1DADYY00002)

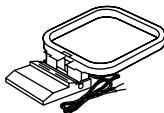

- Remote control transmitter ..... 1 pc.  
(N2QAGB000016)

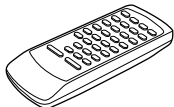

- Batteries ..... 2 pcs.  
R6/LR6, AA, UM-3

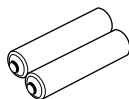

## The remote control

### Batteries

R6/LR6, AA, UM-3

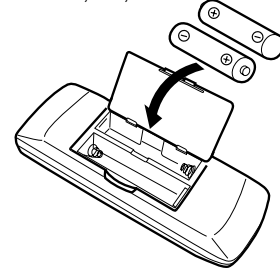

- Insert so the poles (+ and -) match those in the remote control.
- Do not use rechargeable type batteries.

#### Do not:

- mix old and new batteries.
- use different types at the same time.
- heat or expose to flame.
- take apart or short-circuit.
- attempt to recharge alkaline or manganese batteries.
- use batteries if the covering has been peeled off.
- keep together with metallic objects such as necklaces.

Mishandling of batteries can cause electrolyte leakage which can damage items the fluid contacts and may cause a fire.

If electrolyte leaks from the batteries, consult your dealer.

Wash thoroughly with water if electrolyte comes in contact with any part of your body.

Remove if the remote control is not going to be used for a long period of time. Store in a cool, dark place.

Replace if the unit does not respond to the remote control even when held close to the front panel.

### Use

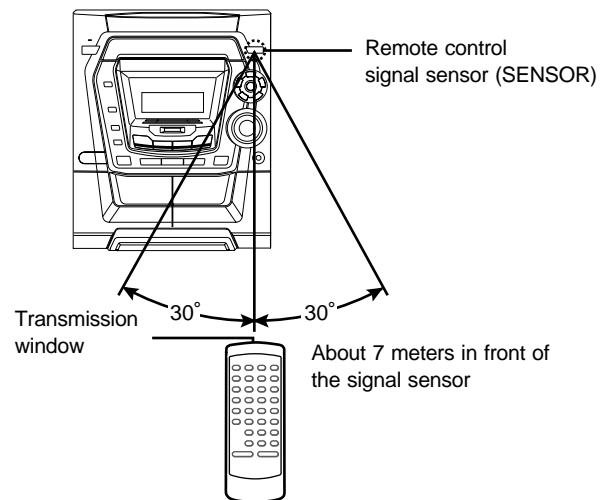

Aim at the sensor, avoiding obstacles, at a maximum range of 7 meters directly in front of the unit.

- Keep the transmission window and the unit's sensor free from dust.
- Operation can be affected by strong light sources, such as direct sunlight, and the glass doors on cabinets.

#### Do not:

- put heavy objects on the remote control.
- take the remote control apart.
- spill liquids onto the remote control.

# Set-up

Connect the AC power supply cord only after all other connections have been made.

## Preparation

Twist and pull off the vinyl tip of the antenna wires and speaker cords.



### 1 FM indoor antenna

Adhesive tape  
Fix where reception is best.

### 2 AM loop antenna

Stand the antenna up on its base.

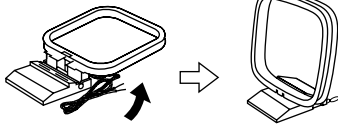

### 4 AC power supply cord

#### Note

The included AC power supply cord is for use with this unit only. Do not use it with other equipment.

#### For your reference

Information you enter into the unit's memory, except for time, remains intact for up to a week after the AC power supply cord is disconnected.

### 3 Speakers

#### Placement

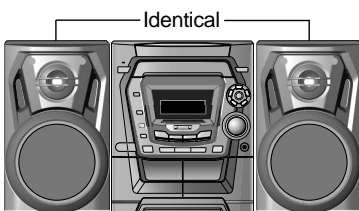

#### Use only the supplied speakers.

The combination of the main unit and speakers provide the best sound. Using other speakers can damage the unit and sound quality will be negatively affected.



#### Caution

- Use the speakers only with the recommended system. Failure to do so may lead to damage to the amplifier and/or the speakers, and may result in the risk of fire. Consult a qualified service person if damage has occurred or if you experience a sudden change in performance.
- Do not attach these speakers to walls or ceilings.

#### Notes

- Keep your speakers at least 10 mm ( $\frac{13}{32}$ " ) away from the system for proper ventilation.
- These speakers do not have magnetic shielding. Do not place them near televisions, personal computers or other devices easily influenced by magnetism.
- You cannot take the front net off the speakers.

#### Connections

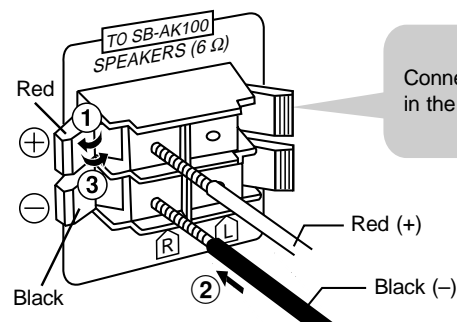

Connect each end of the speaker cables to the terminal lever of the same color so (+) and (-) are correct. Never allow the exposed wires to contact each other when connected.

**Incorrect connection can damage the unit.**

# Front panel controls

## Main unit

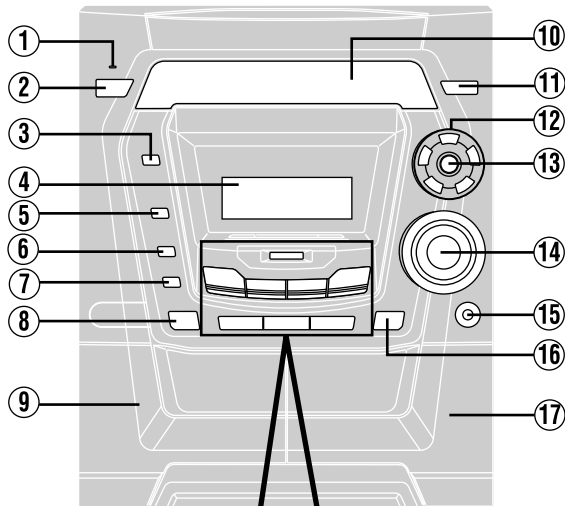

- ① **AC supply indicator (AC IN)**  
This indicator lights when the unit is connected to the AC power supply.
- ② **Standby/on switch (⏻/I, POWER)**  
Press to switch the unit from on to standby mode or vice versa. In standby mode, the unit is still consuming a small amount of power.
- ③ **Display button (DISPLAY)** ..... 8
- ④ **Display**
- ⑤ **Preset EQ select button (PRESET EQ)** ..... 10
- ⑥ **Record button (● REC)** ..... 10
- ⑦ **Deck select button (DECK 1/2)** ..... 10
- ⑧ **Deck 1 open button (⏏ DECK 1 OPEN)** ..... 10
- ⑨ **Deck 1 cassette holder** ..... 10
- ⑩ **Disc tray**
- ⑪ **Remote control signal sensor (SENSOR)** ..... 4
- ⑫ **Disc direct play buttons (1 ~ 5)** ..... 8
- ⑬ **CD tray open/close button (⏏)** ..... 8
- ⑭ **Volume control (VOL DOWN, UP)** ..... 12
- ⑮ **Headphones jack (PHONES)** ..... 11
- ⑯ **Deck 2 open button (⏏ DECK 2 OPEN)** ..... 10
- ⑰ **Deck 2 cassette holder** ..... 10

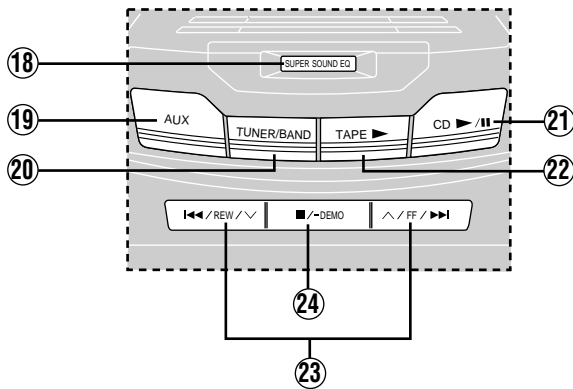

## Center console

- ⑱ **Super sound EQ button (SUPER SOUND EQ)** ..... 10
- ⑲ **AUX button (AUX)** ..... 11
- ⑳ **Tuner/band select button (TUNER/BAND)** ..... 7
- ㉑ **CD play/pause button (CD ▶/||)** ..... 8
- ㉒ **Tape play button (TAPE ▶)** ..... 10
- ㉓ **CD skip/search, tape fast-forward/rewind, tune/preset channel select, time adjust buttons (◀◀/REW/V, ^/FF/▶▶)** ..... 7, 8, 10, 12
- ㉔ **Stop/program clear, demonstration button (■/-DEMO)** ..... 8, 9, 12

## Remote control

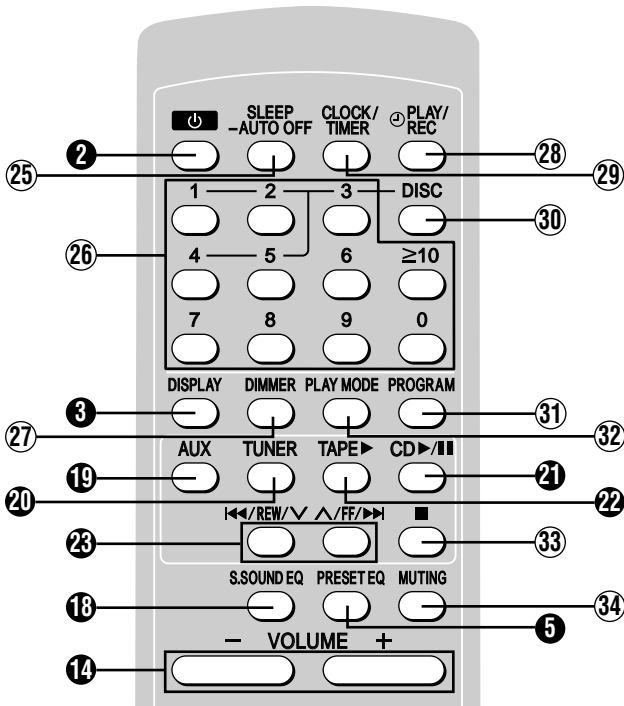

Buttons such as ② function in exactly the same way as the buttons on the main unit.

- ㉕ **Sleep timer/auto off button (SLEEP, -AUTO OFF)** ..... 12, 13
- ㉖ **Numbered buttons (≥10, 1-9, 0)** ..... 7, 9
- ㉗ **Dimmer button (DIMMER)** ..... 12
- ㉘ **Play timer/record timer button (⌚PLAY/REC)** ..... 13
- ㉙ **Clock/timer button (CLOCK/TIMER)** ..... 12, 13
- ㉚ **Disc button (DISC)** ..... 9
- ㉛ **Program button (PROGRAM)** ..... 9
- ㉜ **Play mode select button (PLAY MODE)** ..... 7, 9, 10
- ㉝ **Stop/program clear button (■)** ..... 8, 9
- ㉞ **Muting button (MUTING)** ..... 12

## The radio: manual tuning

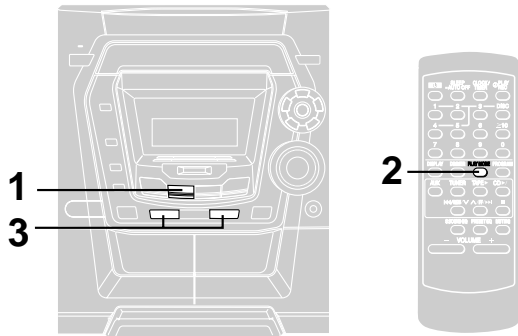

### 1 Press [TUNER/BAND] to select band.

The unit comes on.  
Every time you press the button:  
FM ↔ AM

### 2 Press [PLAY MODE] on the remote control to select "MANUAL".

Every time you press the button:  
MANUAL ↔ PRESET

### 3 Hold down [REW/V] or [FF/FF] for a moment to search for a station.

The frequency stops when it finds a clear station.  
To stop during the process, press [REW/V] or [FF/FF].  
Under excessive interference, a station may not be found.  
Press [REW/V] or [FF/FF] repeatedly to tune step-by-step.

"TUNED" is displayed when a radio station is tuned.  
"ST" is displayed when a stereo FM broadcast is being received.

## If noise is excessive in FM

### Remote control only

#### Hold down [PLAY MODE] to display "MONO".

Monaural sound is selected and noise reduces when reception is weak.

Hold down [PLAY MODE] again to cancel the mode.  
"MONO" is also cancelled if the frequency is changed.

## To receive FM broadcasts allocated in 0.1MHz steps

### Main unit only

Hold down [TUNER/BAND]. The display changes in a few seconds to show the current minimum FM frequency. Continue to hold down the button until the minimum frequency changes. The step is changed.

Changing the step erases all preset stations.  
Repeat the above to change the step back.

### Notes

- After changing the "allocation" setting, the frequencies you previously preset in the memory will be cleared.
- Sound is momentarily interrupted if you load/unload tapes while listening to an AM broadcast.

## The radio: preset tuning

### Remote control only

There are two methods of pre-setting stations.

**Automatic presetting** : All the stations the tuner can receive are preset.

**Manual presetting** : You can select the stations to preset and the order they are preset in.

Up to 15 stations each can be set in the FM and AM bands.

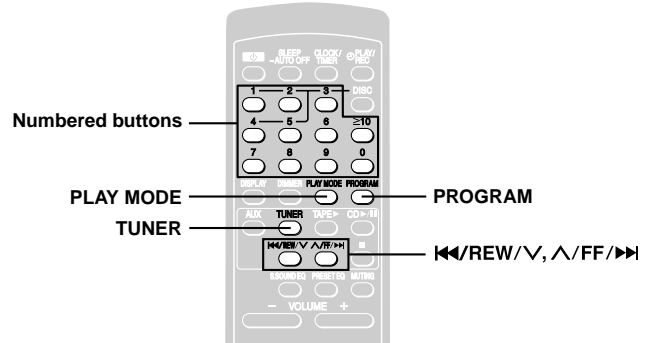

### Preparation:

Press [TUNER] to select "FM" or "AM".

### Automatic presetting

Do the following once each for FM and AM.

**Preparation:** Tune to the frequency where pre-setting is to begin.

#### Hold down [PROGRAM] until the frequency changes.

The tuner presets all the stations it can receive into the channels in ascending order. When finished, the last station memorized is tuned in.

### Manual presetting

Pre-set the stations one at a time.

- 1 Press [PROGRAM] then press [REW/V] or [FF/FF] to tune to the desired station.
- 2 Press [PROGRAM] then press [REW/V] or [FF/FF] to select a channel.
- 3 Press [PROGRAM].

The station occupying a channel is erased if another station is preset in that channel.

## Selecting channels

### Press the numbered buttons to select the channel.

To enter channel 10 or over, press [≥10], then the two digits.

OR

- 1 Press [PLAY MODE] to select "PRESET".
- 2 Press [REW/V] or [FF/FF] to select the channel.

# CDs

## CD selection

Choose CDs with this mark:



### Do not:

- use irregularly shaped CDs.
- attach extra labels and stickers.
- use CDs with labels and stickers that are coming off or with adhesive exuding from under labels and stickers.
- attach scratch proof covers or any other kind of accessory.
- write anything on the CD.
- clean CDs with liquids. (Wipe with a soft, dry cloth.)
- use CDs printed with label printers available on the market.

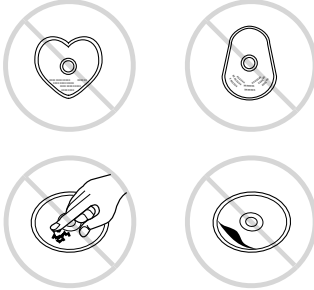

## To prevent damage

Always observe the following points:

- Load only 1 CD on the tray.

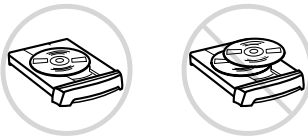

- Load CDs as shown in the figure. An adaptor is not needed with 8 cm CDs (singles).

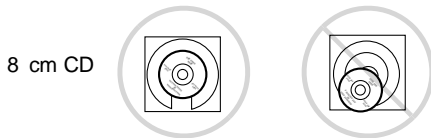

- Set the system on a flat, level surface.
- Always unload all CDs before moving the unit.

### Do not:

- set the unit on top of magazines, inclined surfaces, etc.
- move the unit while a tray is opening/closing, or when loaded.
- put anything except a CD in the tray.
- use cleaning CDs or CDs which are badly warped or cracked.
- disconnect the AC power supply cord from the household AC outlet during disc changing operation.

This unit can play CD-DA (digital audio) format audio CD-R and CD-RW that have been finalized (a process that enables CD-R/CD-RW players to play audio CD-R and CD-RW) upon completion of recording. It may not be able to play some CD-R or CD-RW due to the condition of the recording.

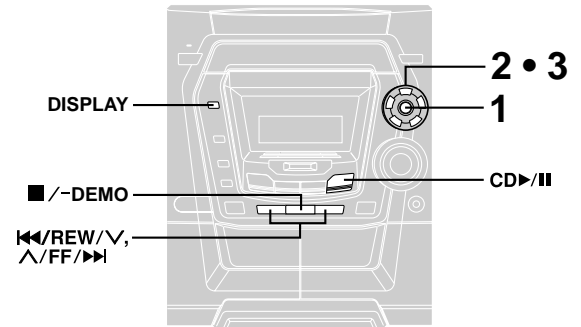

### 1 Press [▲] to open the tray.

The unit comes on.

### 2 Set a CD in the tray. (Label must face upward.)

To continue loading CDs in the other trays

Press another [(1) ~ (5)] to select the required tray and press [▲] to open the tray.

Press [▲] to close the tray.

### 3 Press [(1) ~ (5)] to play your desired disc.

(Alternatively, you can press [CD ▶/II] if the current disc is your desired CD.)

The track number and its elapsed playing time are shown.

Display during play

(example):

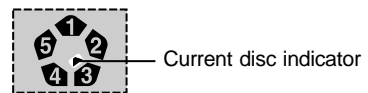

Use the CD Play Mode function's ALL-DISC mode to play CDs in succession. (→ page 9)

### To stop the disc play

Press [■/DEMO].

The total number of tracks and total playing time are shown.

### “▶” indication

It indicates current disc has 16 or more tracks.

### One touch play

During standby mode and when a CD is loaded, press [CD ▶/II] or [(1) ~ (5)].

The unit comes on and play starts.

<b>To pause</b>	Press [CD ▶/II] during play. Press again to resume play.
<b>To search forward/backward</b>	Hold down [◀◀/REW/V] (backward) or [▶▶/FF/II] (forward) during play or pause.
<b>To skip forward/backward</b>	Press [◀◀/REW/V] (backward) or [▶▶/FF/II] (forward) during play or pause.

### Notes

- During 1-RANDOM or A-RANDOM play (→ page 9), you cannot skip to tracks already played.
- During program play (→ page 9), 1-RANDOM or A-RANDOM play, you can search only within the track.
- Always stop the changer before loading or changing CDs. You cannot change CDs while a disc is playing.

## CD display

You can display the remaining play time of the current track.

### Press [DISPLAY] during play or pause.

Every time you press the button:

Elapsed play time ↔ Remaining play time

### Note

When track number 25 or greater is playing, remaining play time display shows “- -: -”.



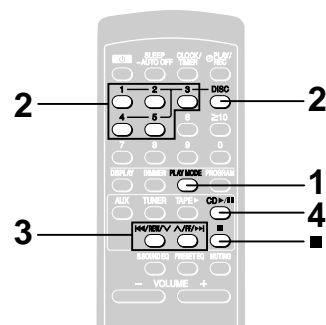
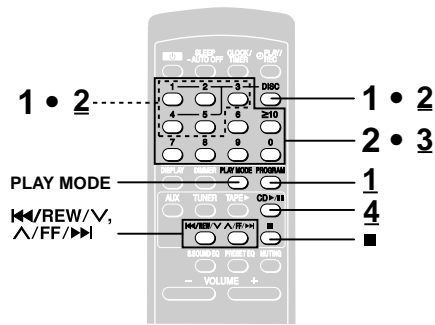

## Starting play from a specific track

### Remote control only

- 1 Press **[DISC]** and (within 10 seconds) **[1]–[5]** to select the disc.
- 2 Select the track with the numbered buttons.  
To select track 10 or over, press  $\geq 10$  then the two digits.  
Play starts from the selected track.

### Note

You cannot use this function with 1-RANDOM or A-RANDOM mode.

## Program play

You can program up to 24 tracks.

### Remote control only

Preparation: Press **[CD ▶/II]** and then **[■]**.

- 1 Press **[PROGRAM]**.  
“PGM” appears.
- 2 Press **[DISC]** and (within 10 seconds) **[1]–[5]** to select the disc.
- 3 Select the tracks with the numbered buttons.  
To select track 10 or over, press  $\geq 10$  then the two digits.  
Repeat steps 2 and 3 to program other tracks.
- 4 Press **[CD ▶/II]** to start play.

### To exit program mode

Press **[PROGRAM]** in the stop mode. (You can replay your program by pressing **[PROGRAM]** then **[CD ▶/II]**.)

### To cancel

Press **[■]** in the stop mode. “CLEAR” is displayed.

### To check program contents

Press **[◀/REW/V]** or **[^/FF/▶]** while “P” is displayed. Every time you press the button, the track number and program order are displayed.

### To add to the program

Do steps 2 and 3 while “P” is displayed.

### Note

You can use repeat mode with program play.

## Repeat play

### Remote control only

Hold down **[PLAY MODE]** during play.  
“C” is displayed.

### To cancel repeat play

Hold down **[PLAY MODE]** to clear “C”.

## To listen to specific CDs and tracks (CD Play Mode function)

### Remote control only

Preparation: Press **[CD ▶/II]** and then **[■]**.

- 1 Press **[PLAY MODE]** to select the desired mode.  
Every time you press the button:

ALL-DISC → 1-SONG → 1-RANDOM → A-RANDOM  
 ↑ 1-DISC ↓

ALL-DISC: Plays **all** loaded discs in succession from the selected disc to the final disc \*.

1-SONG: Plays **one** selected track on the selected disc.

1-RANDOM: Plays **one** selected disc in random order.

A-RANDOM: Plays **all** loaded discs in random order.

1-DISC: Plays **one** selected disc.

(The original display is restored in about 2 seconds.)

Proceed to step 4 when you selected A-RANDOM in step 1.

- 2 Press **[DISC]** and (within 10 seconds) **[1]–[5]** to select the disc.  
The CD starts play if in ALL-DISC, 1-RANDOM or 1-DISC mode.
- 3 Only when you selected “1-SONG” in step 1  
Press **[◀/REW/V]** or **[^/FF/▶]** to select the track.
- 4 Press **[CD ▶/II]** to start play.

### To stop play

Press **[■]**.

### When playback ends

The current play mode will be retained.

### ※ Final disc

For example, if play starts from disc 4, disc 3 will be the “final disc”.  
Order of progression: Disc 4→5→1→2→3

### Note

You can use repeat mode with CD Play Mode function.

## Cassettes

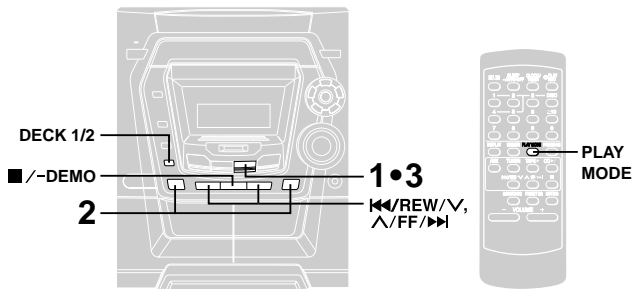

You can use either deck 1 or deck 2 for tape playback.

Use normal position tapes.

High position and metal position tapes can be played, but the unit will not be able to do full justice to the characteristics of these tapes.

- 1 Press [TAPE ▶].**  
The unit comes on.  
If a cassette was loaded, play starts automatically (One touch play).
- 2 Press [▲ DECK 1 OPEN] or [▲ DECK 2 OPEN] and insert the cassette.**  
Insert with the side to be played facing towards you and the exposed tape facing down.  
Close the holder by hand.
- 3 Press [TAPE ▶] to start playback.**

### To stop tape playback

Press [■/-DEMO].

### To fast-forward or rewind

Press [◀◀/REW/V] (rewind) or [▲/FF/▶▶] (fast-forward).

### To select between loaded decks

Press [DECK 1/2] (remote control: [PLAY MODE]).

### Notes

- Tape playback is momentarily interrupted if you open the other deck.
- Tapes exceeding 100 minutes are thin and can break or get caught in the mechanism.
- Tape slack can get caught up in the mechanism and should be taken up before the tape is played.
- Endless tapes can get caught up in the deck's moving parts if used incorrectly.

## Using the built-in sound quality

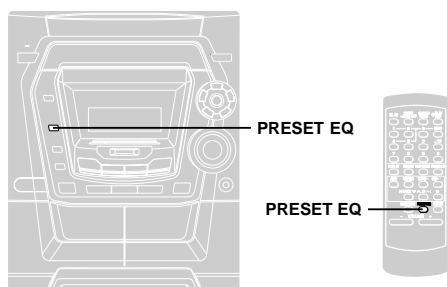

You can choose one of the four types of sound quality.

- HEAVY** : Adds punch to rock  
**SOFT** : For background music  
**CLEAR** : Clarifies higher sounds  
**VOCAL** : Adds gloss to vocals

### Press [PRESET EQ] to select a setting.

Every time you press the button:

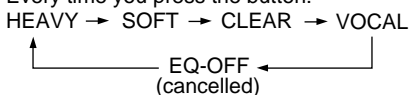

### Note

You cannot use PRESET EQ and SUPER SOUND EQ together.

## Enhancing the sound quality

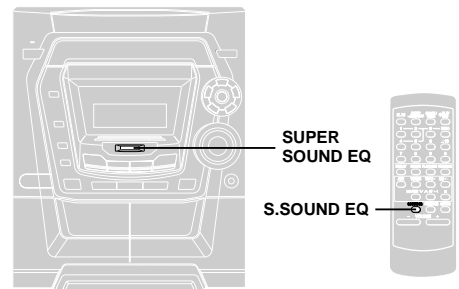

You can enhance the bass and treble effect of the sound.

### Press [SUPER SOUND EQ].

Remote control: Press [S.SOUND EQ].

Press the button again to cancel.

The button light goes out.

## Recording

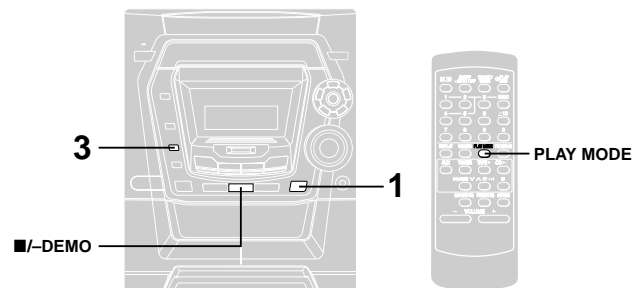

### Selection of tapes for recording

Use normal position tapes.

High position and metal position tapes can be used, but this unit will not be able to record or erase them correctly.

### Preparation:

Wind up the leader tape so recording can begin immediately.

- 1 Press [▲ DECK 2 OPEN] and insert the cassette to be recorded.**

Insert with the side to be recorded facing towards you and the exposed tape facing down.

- 2 Select the source to be recorded.**

#### Radio recording:

Tune in the station. (→ page 7)

#### CD recording:

1. Insert the CD(s) to be recorded.

Press [CD ▶/II] and then [■/-DEMO].

2. Prepare the desired CD recording mode.

To record programmed tracks (→ "Program play" on page 9: steps 1–3).

To record specific CDs/Tracks (→ "To listen to specific CDs and tracks (CD Play Mode function)" on page 9: steps 1–3)

Ensure CD is stopped.

#### Tape-to-tape recording:

1. Press [TAPE ▶] and then [■/-DEMO].

2. Press [▲ DECK 1 OPEN] and insert the cassette you want to record.

- 3 Press [● REC] to start recording.**

### To stop recording

Press [■/-DEMO].

## Recording

### If the tape finishes before the CD

The CD continues playing. Press [■/–DEMO] to stop it.

### To record on the other side of the tape

Turn the tape over and press [● REC].

### Reducing noise when recording AM

#### Remote control only

Hold down [PLAY MODE] while recording.

Every time you hold down the button: BP1 ↔ BP2

Choose the setting with the least noise.

#### Notes

- Changes to volume and sound quality do not affect recording.
- You cannot open deck 1 while recording.
- You cannot fast-forward or rewind one deck while recording with the other.
- When recording an AM broadcast, sound is momentarily interrupted when you start and stop the recording.

## Erasure prevention

Use a screwdriver or similar object to break out the tab.

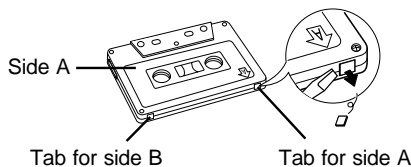

## To re-record on a protected cassette

Cover the hole with adhesive tape.

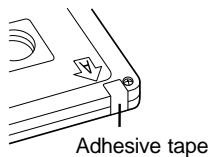

### To erase a tape

1. Press [TAPE ▶] and then [■/–DEMO].
2. Insert the recorded tape into deck 2.  
Ensure there is no tape in deck 1.
3. Press [● REC].

## Optional antenna connections

Use outdoor antenna if radio reception is poor.

### FM outdoor antenna

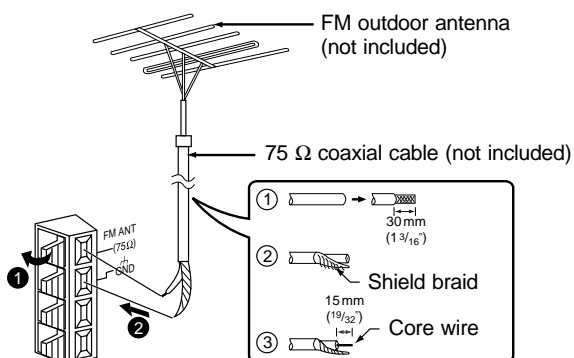

- Disconnect the FM indoor antenna.
- The antenna should be installed by a competent technician.

## Optional antenna connections

### AM outdoor antenna

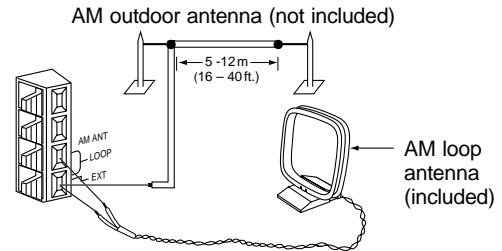

Run a piece of vinyl wire horizontally across a window or other convenient location.  
Leave the loop antenna connected.

#### Note

Disconnect the outdoor antenna when the unit is not in use.  
Do not use the outdoor antenna during an electrical storm.

## External unit connections

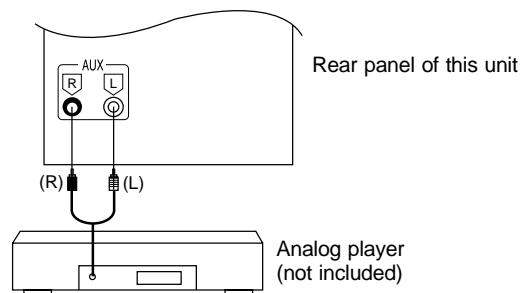

- An analog player with a built-in phono equalizer can be connected.
- For details, refer to the instruction manual of the units which are to be connected.
- When units other than those described above are to be connected, please consult with your audio dealer.

## Using an external unit

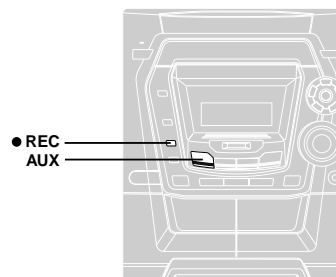

### Listening to an external source

(See above for external unit connection)

1. Press [AUX].  
The unit comes on.
2. Start playback from the external source. (For details, refer to the external unit's instruction manual.)

### Recording from an external source

1. Press [AUX].
2. Press [● REC] (recording starts).
3. Start playback from the external source. (For details, refer to the external unit's instruction manual.)

## Using headphones (not included)

Reduce the volume level before connection.  
Plug type: 3.5 mm (1/8") stereo

#### Note

Avoid listening for prolonged periods of time to prevent hearing damage.

## Turning the demo function off

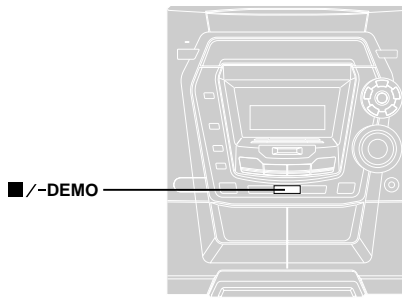

A demonstration of the display is shown if you have not set the clock. You can reduce the power consumed in standby mode by turning it off.

### During standby mode

Hold down **[[-DEMO]]** until "NO DEMO" is displayed.

Every time you hold down the button:  
NO DEMO (off) ↔ DEMO ON (on)

### To show a demonstration of the display

Hold down **[[-DEMO]]** until "DEMO ON" is displayed.

#### Note

DEMO function cannot be turned on when Dimmer is on.

## Convenient functions

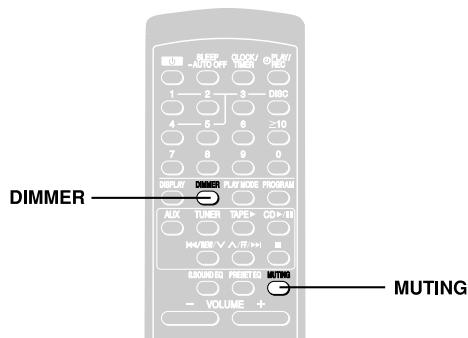

### To dim the display panel

#### Remote control only

Press **[DIMMER]**.

The display is dimmed and the indicator is turned off. (The AC supply indicator remains on.) Press **[DIMMER]** again to restore the display.

### To mute the volume

#### Remote control only

Press **[MUTING]**.

Press the button again to cancel. "MUTING" goes out.

To cancel from the unit, turn **[VOLUME]** to minimum (–dB), then raise it to the required level.

Muting is also cancelled when the unit is turned off.

## Auto-off function

### Remote control only

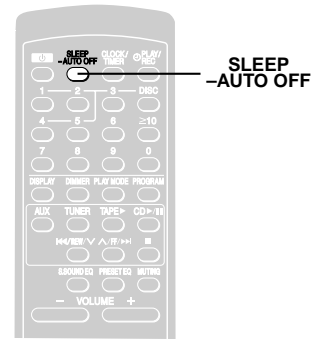

When CD or tape is selected as the source To save power, the unit turns off if it is left unused for ten minutes. This function does not work if the source is tuner or AUX.

Hold down **[–AUTO OFF]**.

"AUTO OFF" is shown on the display.

The setting is maintained even if the unit is turned off. If you select tuner or AUX as the source, "AUTO OFF" goes out. It comes on again when you select disc or tape.

#### To cancel

Hold down **[–AUTO OFF]** again.

## Setting the time

### Remote control only

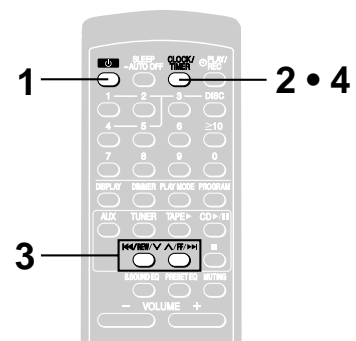

This is a 12-hour clock.

**1** Switch on the power.

**2** Press **[CLOCK/TIMER]** to select "CLOCK".

Every time you press the button:

CLOCK → **[PLAY]** → **[REC]**

↑ Previous display ↓

**3** (within 7 seconds or so)

Press **[REW/V]** or **[FF]** to set the time.

**4** Press **[CLOCK/TIMER]** to finish setting the time.

The display will return to whatever was displayed before you set the time.

#### To display the time

Press **[CLOCK/TIMER]** once when the unit is on or at standby mode. The time is shown for about 5 seconds.

#### Note

Reset the clock regularly to maintain accuracy.

# Using the timers

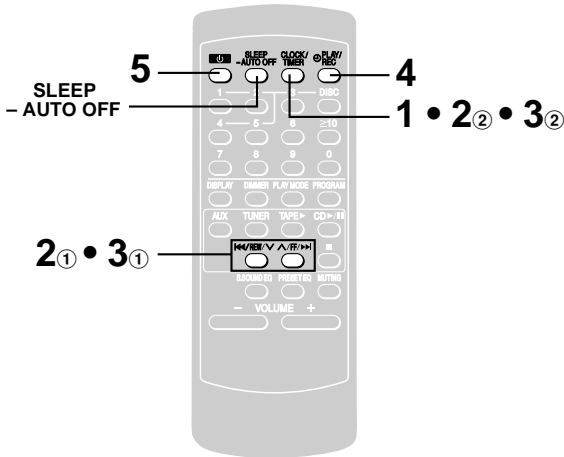

## Using the play/record timer

### Remote control only

You can set the timer to come on at a certain time to wake you up (play timer) or to record a radio station or from the aux source (record timer).

The play and record timers cannot be used together.

#### Preparations:

- Turn the unit on and set the clock (→ page 12).
- **For the play timer**, prepare the desired music source (tape/CD/radio/aux), and set the volume.
- **For the record timer**, check the cassette's erasure prevention tabs (→ page 11) and insert the tape in deck 2 (→ page 10). Tune to the radio station (→ page 7) or select the aux source (→ page 11).

#### 1 Press [CLOCK/TIMER] to select the timer function.

Every time you press the button:

CLOCK → ⊕PLAY → ⊕REC

↑ Previous display ↓

⊕PLAY: to set the play timer

⊕REC: to set the record timer

#### 2 ON time setting

① (Within 8 seconds or so)

Press [◀◀/REW/V] or [∧/FF/▶▶] to set the start time.

② Press [CLOCK/TIMER].

#### 3 OFF time setting

① Press [◀◀/REW/V] or [∧/FF/▶▶] to set the finish time.

② Press [CLOCK/TIMER].

The start and finish times are now set.

#### 4 Press [⊕PLAY/REC] to display the timer indicator.

Every time you press the button:

⊕PLAY → ⊕REC

↑ (off) ↓

⊕PLAY: to turn the play timer on

⊕REC: to turn the record timer on

(The indicator doesn't appear if the start and finish times or the clock hasn't been set.)

#### 5 Press [⊕] to turn the unit off.

The unit must be off for the timers to operate.

- **Play timer:** Play will start in the set condition at the set time with volume increasing gradually to the set level.
- **Record timer:** Recording will start 30 seconds before the set time with the volume muted.

#### To cancel the timer

Press [⊕PLAY/REC] to clear the timer indicator from the display. (The timer comes on at the set time everyday if the timer is on.)

#### To change the settings (when the unit is on)

##### To change the play/record times

Do steps 1, 2, 3 and 5.

##### To change the source or volume

1. Press [⊕PLAY/REC] to clear the timer indicator from the display.
2. Make changes to the source or volume.
3. Do steps 4 to 5.

##### To change the timer

Press [⊕PLAY/REC] to select the desired timer.

Every time the button is pressed:

⊕PLAY → ⊕REC

↑ (off) ↓

##### To check the settings

Press [CLOCK/TIMER] while the unit is on to select "⊕PLAY" or "⊕REC".

The settings are shown in the following order:

Play timer: start time → finish time → source → volume

Record timer: start time → finish time → source

To check the settings while the unit is off, press [CLOCK/TIMER] twice.

#### If you use the unit after the timers are set

After using, check that the correct tape/CD are loaded before turning the unit off.

#### Notes

- If you turn the unit off and on again while a timer is functioning, the finish time setting will not be activated.
- If you selected AUX as the source, when the timer comes on, the unit turns on and engages "AUX" as the source. If you want to playback or record from a connected unit, set that unit's timer to the same time. (See the connected unit's instruction manual.)

## Using the sleep timer

### Remote control only

This timer turns the unit off after a set time.

While enjoying the desired source:

Press [SLEEP] to select the time (minutes).

Every time you press the button:

→ SLEEP 30 → SLEEP 60 → SLEEP 90 → SLEEP 120 → SLEEP OFF →

#### To cancel the sleep timer

Press [SLEEP] to select "SLEEP OFF".

#### To confirm the remaining time

Press [SLEEP] once.

The remaining time is shown for about 5 seconds.

#### To change the setting

Press [SLEEP] to select the new setting.

You can use the sleep timer in combination with the play/record timer. Make sure the unit is off before the play/record timer's start time.

#### Note

The sleep timer will be turned off when you start recording from a CD.

# Troubleshooting guide

Before requesting service, make the below checks. If you are in doubt about some of the check points, or if the remedies indicated in the chart do not solve the problem:

*In the U.S.A., contact the Panasonic Customer Call Center at 1-800-211-7262, or e-mail [consumerproducts@panasonic.com](mailto:consumerproducts@panasonic.com), or web site (<http://www.panasonic.com>).*

*In Canada, contact Panasonic Canada Inc. Customer Care Centre at 905-624-5505, web site ([www.panasonic.ca](http://www.panasonic.ca)), or an authorized Servicentre closest to you.*

Reference pages are shown as black circled numbers ❸.

## Common Problems

No sound. Sound stops.	Turn the volume up. Switch off the unit, determine and correct the cause, then switch the unit on. Causes include shorting of the positive and negative speaker wires, straining of the speakers through excessive volume or power, and using the unit in a hot environment.
Sound is unfixed, reversed or comes from one speaker only.	Check the speaker connections. ❸
Humming heard during play.	An AC power supply cord or fluorescent light is near the cables. Keep other appliances and cords away from this unit's cables.
"ERROR" is displayed.	Incorrect operation performed. Read the instructions and try again.
"- :- -" appears on the display at standby mode.	You plugged the AC power supply cord in for the first time or there was a power failure recently. Set the time. ❷
"F61" is displayed.	Check and correct the speaker cords connection. ❸ If this does not fix the problem, there is a power supply problem. Consult the dealer.

## Listening to the radio

Noise is heard. The stereo indicator flickers or doesn't light. Sound is distorted.	Use an outdoor antenna. ❶
A beat sound is heard.	Turn the TV off or separate it from the unit.
A low hum is heard during AM broadcasts.	Separate the antenna from other cables and cords.

## When there is a television set nearby

The picture on the TV disappears or stripes appear on the screen.	The location and orientation of the antenna are incorrect. If you are using an indoor antenna, change to an outdoor antenna. The TV antenna wire is too close to the unit. Separate the antenna wire of the TV set from the unit.
---	--

## Using the cassette deck

Poor quality sound.	Clean the heads. <b>See below</b>
Recording is not possible.	If the erasure prevention tabs have been removed, cover the holes with adhesive tape. ❶

## Playing discs

The display is wrong or play won't start.	The disc may be upside down. ❸ Wipe the disc. Replace the disc if it is scratched, warped, or non-standard. Condensation may have formed inside the unit due to a sudden change in temperature. Wait about an hour for it to clear and try again.
CD-RW cannot be read.	The disc was incompletely formatted. Use the recording equipment to fully format the disc before recording.
"TAKE OUT/DISC" appears on the display.	There is a problem with the disc mechanism. (A power failure may have occurred.) The tray will open automatically. Remove the disc from the tray, and after ensuring there is no disc in the tray, close it. The unit will make the disc changing noises for a few moments and then it should operate normally.
The changer cannot change to the selected discs or play won't start.	Press [PLAY MODE] on the remote control to clear 1-SONG mode and try again.

## Remote control

Remote control doesn't work.	Check that the batteries are inserted correctly. ❹ Replace the batteries if they are worn.
------------------------------	---

# Maintenance

### If the surfaces are dirty

To clean this unit, wipe with a soft, dry cloth.

- Never use alcohol, paint thinner or benzine to clean this unit.
- Before using a chemically treated cloth, read the instructions that came with the cloth carefully.

### For a cleaner, crisper sound

Clean the heads regularly to assure good quality playback and recording.

Use a cleaning tape (not included).

## Product Service

- 1. Damage requiring service**—The unit should be serviced by qualified service personnel if:
  - (a) The AC power supply cord or AC adaptor has been damaged; or
  - (b) Objects or liquids have gotten into the unit; or
  - (c) The unit has been exposed to rain; or
  - (d) The unit does not operate normally or exhibits a marked change in performance; or
  - (e) The unit has been dropped or the cabinet damaged.
- 2. Servicing**—Do not attempt to service the unit beyond that described in these operating instructions. Refer all other servicing to authorized servicing personnel.
- 3. Replacement parts**—When parts need replacing ensure the servicer uses parts specified by the manufacturer or parts that have the same characteristics as the original parts. Unauthorized substitutes may result in fire, electric shock, or other hazards.
- 4. Safety check**—After repairs or service, ask the servicer to perform safety checks to confirm that the unit is in proper working condition.

### Product information

For product information or assistance with product operation:  
**In the U.S.A., contact the Panasonic Customer Call Center at 1-800-211-7262, or e-mail [consumerproducts@panasonic.com](mailto:consumerproducts@panasonic.com), or web site (<http://www.panasonic.com>).**

**In Canada, contact Panasonic Canada Inc. Customer Care Centre at 905-624-5505, web site ([www.panasonic.ca](http://www.panasonic.ca)), or an authorized Servicentre closest to you.**

## Servicenter List (ONLY FOR U.S.A.)

**Panasonic**

**Technics**

**Quasar**

**For Product Information, Operating Assistance, Literature Request, Dealer Locations, and all Customer Service inquiries please contact:  
 1-800-211-PANA (7262), Monday–Friday 9 am–9 pm; Saturday–Sunday 9 am–7pm, EST.**

**Web Site: <http://www.panasonic.com>  
 You can purchase parts, accessories or locate your nearest servicenter by visiting our Web Site.**

### Accessory Purchases:

1-800-332-5368 (Customer Orders Only)  
 Panasonic Services Company 20421 84th Avenue South, Kent, WA 98032  
 (6 am to 5 pm Monday–Friday; 6 am to 10:30 am Saturday; PST)  
 (Visa, MasterCard, Discover Card, American Express, Check)

### Factory Servicenters Locations

<p><b>CALIFORNIA</b>            6550 Katella Avenue            Cypress, CA 90630</p> <p>800 Dubuque Avenue            S. San Francisco            CA 94080</p> <p>3878 Ruffin Road            Suite A            San Diego, CA 92123</p> <p><b>FLORIDA</b>            3700 North 29<sup>th</sup> Avenue            Suite 102            Hollywood, FL 33020</p>	<p><b>GEORGIA</b>            8655 Roswell Road            Suite 100            Atlanta, GA 30350</p> <p><b>ILLINOIS</b>            1709 North Randall Road            Elgin, IL 60123</p> <p><b>MASSACHUSETTS</b>            60 Glacier Drive            Suite G            Westwood, MA 02090</p>	<p><b>MINNESOTA</b>            7850-12<sup>th</sup> Avenue South            Airport Business Center            Bloomington, MN 55425</p> <p><b>OHIO</b>            2236 Waycross Road            Civic Center Plaza            Forest Park, OH 45240</p> <p><b>PENNSYLVANIA</b>            2221 Cabot Blvd. West            Suite B            Langhorne, PA 19047</p>	<p><b>TEXAS</b>            13615 Welch Road            Suite 101            Farmers Branch            TX 75244</p> <p><b>WASHINGTON</b>            20425-84<sup>th</sup> Avenue South            Kent, WA 98032</p> <p><b>HAWAII</b>            99-859 Iwaiwa Street            Aiea, Hawaii 96701            Phone (808) 488-1996            Fax (808) 486-4369</p>
---	--	--	--

### Service in Puerto Rico

**Matsushita Electric of Puerto Rico, Inc. Panasonic Sales Company/Factory Servicenter:  
 Ave. 65 de Infanteria, Km. 9.5, San Gabriel Industrial Park, Carolina, Puerto Rico 00985  
 Phone (787) 750-4300 Fax (787) 768-2910**

# Specifications

## AMPLIFIER SECTION

**Power output**  
**10% Total harmonic distortion**  
**60 Hz–16 kHz, both channels driven**  
 40 W per channel (6 Ω)

**Power output**  
**10% Total harmonic distortion**  
**1 kHz, both channels driven**  
 50 W per channel (6 Ω)

**Input sensitivity**  
**AUX** 250 mV  
**Input Impedance**  
**AUX** 13.3 kΩ

## FM TUNER SECTION

**Frequency range**  
 87.9 – 107.9 MHz (200 kHz steps)  
 87.5 – 108.0 MHz (100 kHz steps)

**Sensitivity** 2.5 μV (IHF)  
**S/N 26 dB** 2.2 μV  
**Antenna terminal(s)** 75 Ω (unbalanced)

## AM TUNER SECTION

**Frequency range**  
 520 – 1710 kHz (10 kHz steps)

**Sensitivity**  
**S/N 20 dB (at 1000 kHz)** 560 μV/m

## CASSETTE DECK SECTION

**Track system** 4 track, 2 channel

**Heads**  
**Record/playback** Solid permalloy head  
**Erase** Double gap ferrite head

**Motor** DC servo motor  
**Recording system** AC bias 100 kHz  
**Erasing system** AC erase 100 kHz  
**Tape speed** 4.8 cm/s (1<sup>7</sup>/<sub>8</sub> ips)

**Overall frequency response**  
**(+3 dB, –6 dB at DECK OUT)**  
**NORMAL (TYPE I)** 35 Hz – 14 kHz  
**S/N** 50 dB (A weighted)  
**Wow and flutter** 0.18% (WRMS)  
**Fast forward and rewind time**  
 Approx. 120 seconds with  
 C-60 cassette tape

## CD SECTION

**Sampling frequency** 44.1 kHz  
**Decoding** 16 bit linear  
**Beam source/wavelength**  
 Semiconductor laser/780 nm

**Number of channels** Stereo  
**Frequency response**

20 Hz–20 kHz (+1, –2 dB)  
 Below measurable limit  
**Digital filter** 8 fs  
**D/A converter** MASH (1 bit DAC)

## SPEAKER SECTION

**Type** 2 way speaker system

**Speaker(s)**  
**Woofer** 10 cm (4") cone type  
**Super tweeter** Piezo type

**Impedance** 6 Ω  
**Input power** 80 W (Music)

**Output sound pressure level**  
 86 dB/W (1.0 m)

**Cross over frequency** 10 kHz  
**Frequency range** 54 Hz–19 kHz (–16 dB)  
 75 Hz–17 kHz (–10 dB)

**Dimensions (WxHxD)** 190 x 315 x 190 mm  
 (7<sup>15</sup>/<sub>32</sub>" x 12<sup>13</sup>/<sub>32</sub>" x 7<sup>19</sup>/<sub>32</sub>" )

**Mass** 2.4 kg (5.3 lb.)

## GENERAL

**Power supply** AC 120 V, 60 Hz  
**Power consumption** 120 W

**Standby** Approx. 0.49 W  
**Dimensions (WxHxD)** 250 x 315 x 345 mm  
 (9<sup>27</sup>/<sub>32</sub>" x 12<sup>13</sup>/<sub>32</sub>" x 13<sup>19</sup>/<sub>32</sub>" )

**Mass** 6.4 kg (14.1 lb.)

## Notes:

- Specifications are subject to change without notice.  
 Mass and dimensions are approximate.
- Total harmonic distortion is measured by the digital spectrum analyzer.

# Warranty (ONLY FOR U.S.A.)

Panasonic Consumer Electronics Company,  
 Division of Matsushita Electric Corporation of America  
 One Panasonic Way Secaucus, New Jersey 07094

Panasonic Sales Company, Division of Matsushita Electric  
 of Puerto Rico, Inc.  
 Ave. 65 de Infantería, Km. 9.5  
 San Gabriel Industrial Park, Carolina, Puerto Rico 00985

## Panasonic/Technics Audio Products Limited Warranty

Panasonic Consumer Electronics Company or Panasonic Sales Company (collectively referred to as "the Warrantor") will repair or replace this product with new or refurbished parts or equivalent product, free of charge in the U.S.A. or Puerto Rico, in the event of a defect in materials or workmanship as follows (all time periods commence from the date of original purchase):

**AUDIO PRODUCTS**—labor and parts for one (1) year.

**ALL AUDIO RACKS (cabinets)**—parts only 30 days.

**TECHNICS STAND ALONE SPEAKERS, SUBWOOFER SPEAKERS**—labor and parts for three (3) years.

**USB READER-WRITER, PERSONAL COMPUTER CARD ADAPTERS**—(when applicable)—exchange defective unit with a new or refurbished one for one (1) year.

**ACCESSORIES—HEADPHONES, CARTRIDGES, MICROPHONES, ADAPTERS**—labor and parts for ninety (90) days.

**RECHARGEABLE BATTERIES**—(when applicable)—exchange defective item for new one for ten (10) days. Non-rechargeable batteries are not warranted.

**SD MEMORY CARDS, RECHARGEABLE BATTERY PACKS**—(when applicable)—exchange defective item for new one for ninety (90) days. Non-rechargeable battery packs are not warranted.

Carry-in or mail-in service in the U.S.A. can be obtained during the warranty period by contacting a Panasonic Services Company (PASC) Factory Servicer listed in the Servicer Directory. Or call toll free, 1-800-211-7262 to locate a PASC authorized Servicer. Carry-in or mail-in service in Puerto Rico can be obtained during the warranty period by calling the Panasonic Sales Company telephone number listed in the Servicer Directory.

This warranty is extended only to the original purchaser. A purchase receipt or other proof of date of original purchase will be required before warranty service is rendered.

This warranty only covers failures due to defects in materials and workmanship which occur during normal use and does not cover normal wear to the stylus (when applicable) or a dealer installed cartridge or stylus. The warranty does not cover damages which occur in shipment or failures which are caused by products not supplied by the warrantor, or failures which result from accident, misuse, abuse, neglect, mishandling, faulty installation, misapplication, set-up adjustments, maladjustment of consumer controls, improper operation or maintenance, improper antenna, inadequate signal reception or pick-up, alteration, modification, power line surge, improper voltage supply, lightning damage, commercial use, such as; hotel, office, restaurant, or other business or rental use of the product, or service by anyone other than a PASC Factory Servicer or a PASC authorized Servicer, or damage that is attributable to acts of God.

### LIMITS AND EXCLUSIONS

There are no express warranties except as listed above.

THE WARRANTOR SHALL NOT BE LIABLE FOR INCIDENTAL OR CONSEQUENTIAL DAMAGES RESULTING FROM THE USE OF THIS PRODUCT, OR ARISING OUT OF ANY BREACH OF THIS WARRANTY, INCLUDING WITHOUT LIMITATION, DAMAGE TO TAPES, RECORDS OR DISCS. ALL EXPRESS AND IMPLIED WARRANTIES, INCLUDING THE WARRANTIES OF MERCHANTABILITY, AND FITNESS FOR A PARTICULAR PURPOSE, ARE LIMITED TO THE APPLICABLE WARRANTY PERIOD SET FORTH ABOVE. Some states do not allow the exclusion or limitation of incidental or consequential damages, or limitations on how long an implied warranty lasts, so the above exclusions or limitations may not apply to you.

This warranty gives you specific legal rights and you may also have other rights which vary from state to state.

If a problem with this product develops during or after the warranty period, you may contact your dealer or Servicer. If the problem is not handled to your satisfaction, then write to the Consumer Affairs Department at the company address indicated above.

If you ship the product

Carefully pack and send it prepaid, adequately insured and preferably in the original carton.

Attach a postage-affixed letter, detailing the complaint, to the outside of the carton.

Do NOT send the product to the Executive or Regional Sales offices. They are NOT equipped to make repairs.

Panasonic Consumer Electronics  
 Company, Division of Matsushita  
 Electric Corporation of America  
 One Panasonic Way Secaucus,  
 New Jersey 07094  
<http://www.panasonic.com>

Panasonic Sales Company,  
 Division of Matsushita Electric of  
 Puerto Rico, Inc. ("PSC")  
 Ave. 65 de Infantería, Km. 9.5  
 San Gabriel Industrial Park, Carolina,  
 Puerto Rico 00985

Panasonic Canada Inc.  
 5770 Ambler Drive  
 Mississauga, Ontario  
 L4W 2T3  
[www.panasonic.ca](http://www.panasonic.ca)

